



**FAHRZEUG-
EINRICHTUNGEN**

**FITTINGS FOR
COMMERCIAL VEHICLES**



NISSAN NV400



STOREVAN ORANGE PLANET - STOREVAN ORANGE PLANET

**STOREVAN ORANGE PLANET**

Nachhaltigkeit und ökologische Entwicklung sind Themen von großem, aktuellem Interesse, entstanden durch das steigende Bewusstsein, dass auf die Umweltbalance aufgrund der zyklischen Veränderungen und Erneuerungen geachtet werden muss.

STOREVAN ORANGE PLANET

Environmental sustainability and eco-compatible development are topics of great interest and relevance, arising from the growing awareness that it is important to pay attention to the environmental balance.

ZERTIFIZIERUNGEN - CERTIFICATIONS

ZERTIFIZIERTE PRODUKTION

- Nach ISO 9001:2008 zertifiziert.
- Erfolgreicher CRASH TEST durchgeführt nach ECE-R17 mit einer Aufprallgeschwindigkeit von 50 Km/h.
- GS-Zertifizierung für Inneneinrichtungen und Laderampen.
- GS-Zertifizierung für Dachträger und Leiterträger.

CERTIFIED PRODUCTION

- ISO 9001:2008 certified.
- Brilliantly passed the CRASH TEST carried out according to the most recent European regulations ECE-R17 with impact at 50 Km/h.
- GS certification for interior fittings and loading ramps.
- GS certification for roof and ladder racks.



CRASH TEST
ECE-R17



StoreVan ist weltweit der einzige Hersteller von Nutzfahrzeugeinrichtungen, der mit dieser Technologie arbeitet.

StoreVan is the sole LCV's equipment manufacturer worldwide to make use of this technology.



GALVANNEALED STAHL

Galvannealed Blech ist eine Variante von feuerverzinktem Blech. Das Produkt unterliegt einem Feuerbeschichtungsprozess und wird bis ca. 550 °C erhitzt. Dies ermöglicht es dem Zink mit dem Stahlblech eine Legierung einzugehen. Das Ergebnis ist eine Beschichtung mit einer gleichförmigen, feinkörnigen Kristallstruktur an der Beschichtungsoberfläche und einer **sehr hohen Oberflächenqualität und Korrosionsbeständigkeit**.

Dieses Verfahren ist ideal für Automotive Anwendungen. StoreVan hat diese Technik nun auch im Bereich Nutzfahrzeugeinrichtungen implementiert.

DAS VERFAHREN DER KATHODISCHEN ACRYL-TAUCHLACKIERUNG

Die kathodische Acryl-Beschichtung ist eine Oberflächenbehandlung, die den einzelnen Teilen der Einrichtung eine **extrem hohe Korrosionsbeständigkeit** verleiht. Das Tauchverfahren gewährleistet eine **gleichmäßige Beschichtung** und einen lang anhaltenden Schutz egal gegen welche Stoffe. Das Acrylharz schützt den Lack bei direkter Belichtung durch die Witterung gegen Ausbleichen und gegen Veränderungen der Korrosionsbeständigkeit.

- Korrosionsbeständigkeit von über 500 Stunden (ASTM D1735 Luftfeuchtigkeit)
- Ausgezeichnete Härte mit einem Mindestrating von 2H



GALVANNEALED STEEL

Galvannealed sheet is a variant of hot-dip galvanized sheet. The product is subject to a hot-dip-galvanization process and subsequently heated to approximately 550°C, combining the zinc with the sheet surface to make an alloy with iron. The result is a uniform zinc coating with a fine-grained crystalline structure along with a **much higher surface quality and corrosion resistance**. This process is ideal for automotive applications. StoreVan introduced and implemented this technology in the commercial vehicles equipment field.

CATHODIC DIP PAINTING WITH ACRYLIC RESIN

Cataphoresis painting is a paint surface treatment able to give the equipment elements a **remarkable resistance to corrosion**; characterized by **uniform deposit** of an acrylic resin on the element surface, it ensures long lasting and high protection against chemical agents and other types of surface attacks. The acrylic resin allows a direct exposure to atmospheric agents without altering its technical features. This process ensures an increased protection against rust.

- Corrosion resistance of more than 500 hours (humidity ASTM D1735)
- Excellent hardness with a minimum rating of 2H





BODENPLATTE UND SEITENVERKLEIDUNGEN - FLOORING AND LININGS

- Bodenplatte und Seitenverkleidungen für Fahrzeug mit rechter Schiebetür und Seitenwänden aus Vollblech.
- Flooring and linings for right side door vehicle with metal sheet sidewalls.

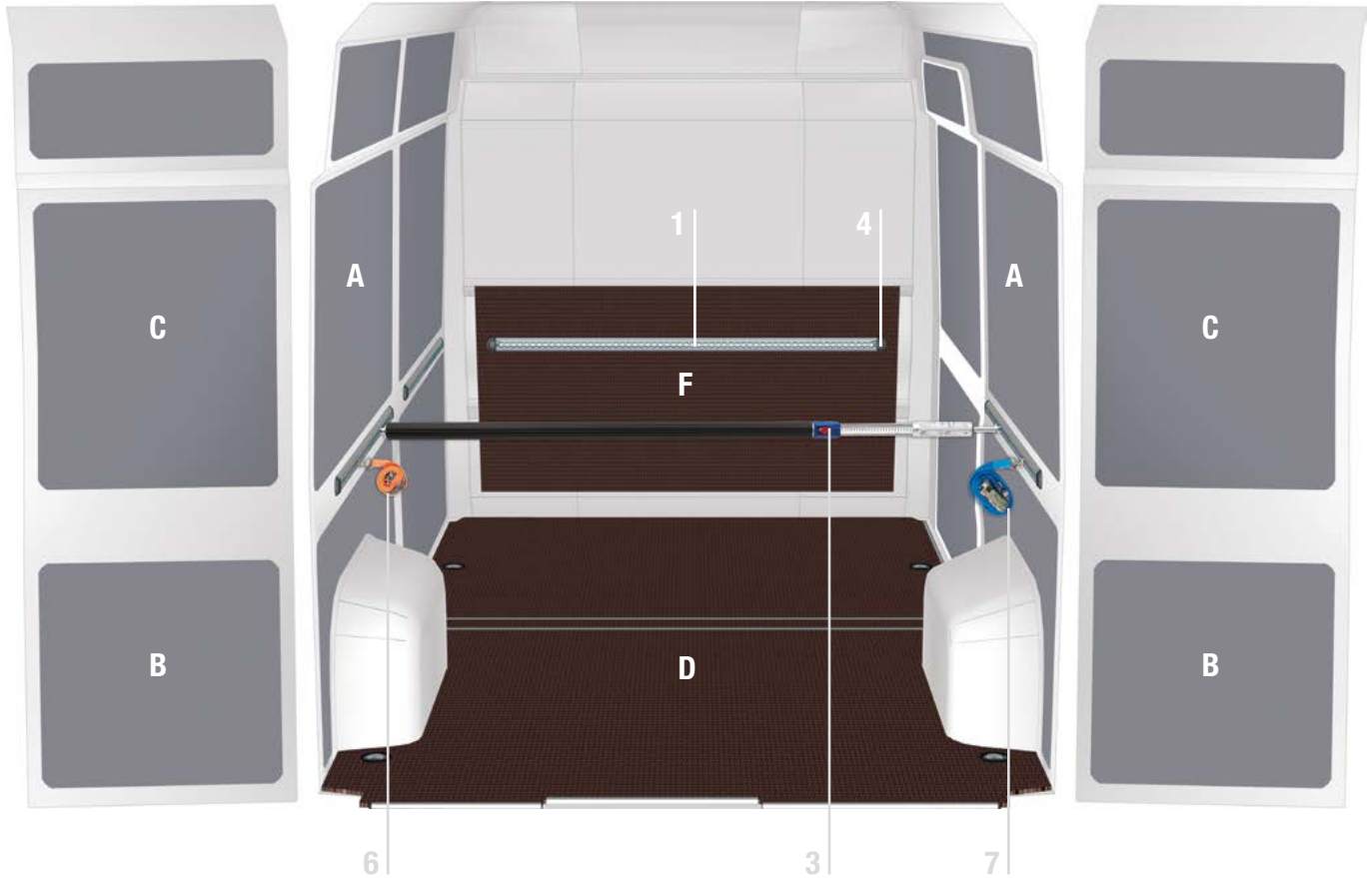

FAHRZEUG VEHICLE	BODENPLATTE 12 mm 12 mm FLOORING	SEITENVERKLEIDUNG LINING	SEITENVERKLEIDUNG LINING	RÜCKWANDPLATTE BULKHEAD
	D	A+B	C	F
	ART. NR. / ITEM NO.	ART. NR. / ITEM NO.	ART. NR. / ITEM NO.	ART. NR. / ITEM NO.
Fahrzeugtyp - Model L1 H1 ^A	PIL 213 35,80 kg	PAN 210 12,84 kg	PAR 208 2,13 kg	PIR 203 9,75 kg
Fahrzeugtyp - Model L1 H2 ^A	PIL 213 35,80 kg	PAN 211 14,20 kg	PAR 209 2,63 kg	PIR 203 9,75 kg
Fahrzeugtyp - Model L2 H2-H3 ^A	PIL 214 43,20 kg	PAN 212 21,85 kg	PAR 209 2,63 kg	PIR 203 9,75 kg
Fahrzeugtyp - Model L3 H2-H3 ^A	PIL 217 53,20 kg	PAN 214 25,15 kg	PAR 209 2,63 kg	PIR 203 9,75 kg
Fahrzeugtyp - Model L3 H2-H3 ^B	PIL 215 50,20 kg	PAN 213 25,76 kg	PAR 209 2,63 kg	PIR 203 9,75 kg
Fahrzeugtyp - Model L3 H2-H3 ^C	PIL 216 48,10 kg	PAN 213 25,76 kg	PAR 209 2,63 kg	PIR 203 9,75 kg
Fahrzeugtyp - Model L4 H2-H3 ^B	PIL 225 59,85 kg	PAN 215 30,80 kg	PAR 209 2,63 kg	PIR 203 9,75 kg
Fahrzeugtyp - Model L4 H2-H3 ^C	PIL 218 57,62 kg	PAN 215 30,80 kg	PAR 209 2,63 kg	PIR 203 9,75 kg

^A Frontantrieb, Einzelbereifung - Front-wheel drive, single wheels

^B Heckantrieb, Einzelbereifung - Rear-wheel drive, single wheels

^C Heckantrieb, Zwillingsbereifung - Rear-wheel drive, twin wheels

BODENPLATTE UND SEITENVERKLEIDUNGEN - FLOORING AND LININGS

PAN

- Seitenverkleidung aus Polypropylen für:
 - linke Seitenwand
 - rechte Seitenwand und Schiebetür
 - unteren Teil der Heckflügeltüren
- Polypropylene linings for:
 - LH sidewall
 - RH sidewall and sliding door
 - lower part of rear hinged doors

PAR

- Seitenverkleidung aus Polypropylen für:
 - oberen Teil der Heckflügeltüren
- Polypropylene linings for:
 - upper part of rear hinged doors

PIL

- Bodenplatte aus Multiplex mit Phenolbeschichtung, Stärke 12 mm, für das Originalverankerungssystem des Fahrzeugs vorgebohrt.
- 12 mm thick wooden flooring with phenolic coating set for the vehicles original anchoring system

PIR

- Kabinenrückwandplatte aus Multiplex mit Phenolbeschichtung, Stärke 12 mm
- 12 mm thick wooden bulkhead panel with phenolic coating

LADUNGSSICHERUNG - LOAD SECURING

BESCHREIBUNG - DESCRIPTION

- Horizontale Aluschiene.
- Horizontal aluminium bar.

ALUSCHIENE - BAR

1

LÄNGE - LENGTH

ART. NR. / ITEM NO. F 22 FC V18029 05 00	500 mm
ART. NR. / ITEM NO. F 22 FC V18029 10 00	1000 mm
ART. NR. / ITEM NO. F 22 FC V18029 15 00	1500 mm
ART. NR. / ITEM NO. F 22 FC V18029 20 00	2000 mm
ART. NR. / ITEM NO. F 22 FC V18029 25 00	2500 mm

BESCHREIBUNG - DESCRIPTION

- Horizontale Aluschiene für Seitenwände.
- Horizontal aluminium bar for side panels.

ALUSCHIENE - BAR

2

LÄNGE - LENGTH

ART. NR. / ITEM NO. F 22 FC V18025 05 00	500 mm
ART. NR. / ITEM NO. F 22 FC V18025 10 00	1000 mm
ART. NR. / ITEM NO. F 22 FC V18025 15 00	1500 mm

BESCHREIBUNG - DESCRIPTION

- Teleskopische Spannstanze.
- Telescopic load restraining bar.

STANGE - BAR

3

HÖHE - HEIGHT

ART. NR. / ITEM NO. F 22 FC V22149 00 00	650-900 mm
ART. NR. / ITEM NO. F 22 FC V22131 00 00	1250-1750 mm
ART. NR. / ITEM NO. F 22 FC V22017 00 00	1550-2050 mm

BESCHREIBUNG - DESCRIPTION

- Endstück aus Kunststoff für Aluschiene Serie V18029.
- Plastic end cap for bar series V18029.

ENDSTÜCK FÜR ALUSCHIENE - PLASTIC END CAP FOR BAR

4

ART. NR. / ITEM NO. F 22 FC V22106 00 00

BESCHREIBUNG - DESCRIPTION

- Zurring.
- Ring stud fitting.

ZURRRING - RING STUD FITTING

5

ART. NR. / ITEM NO. F 22 FC V22090 00 00

BESCHREIBUNG - DESCRIPTION

- Zurring mit Hebelspannschloss 2500+500.
- Load restraining belt with clamp 2500+500.

ZURRGURT - BELT

6

ART. NR. / ITEM NO. F 22 FC V22136 00 00

BESCHREIBUNG - DESCRIPTION

- Zurring mit Ratschenschloss 2500+500.
- Load restraining belt with ratchet 2500+500.

ZURRGURT - BELT

7

ART. NR. / ITEM NO. F 22 FC V22124 00 00

Für weitere Informationen fordern Sie bitte unseren „Ladungssicherung“ - Katalog an

For more information, ask for our “Load Securing” catalogue





FAHRZEUGEINRICHTUNGSBEISPIELE - FITTINGS EXAMPLES

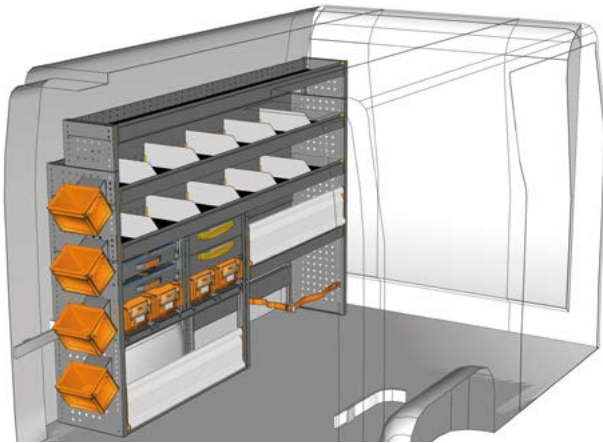

BEISPIEL - EXAMPLE

MA 2014 01*

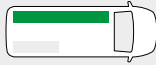

B=2032 T=365 H=1400 mm - W=2032 D=365 H=1400 mm

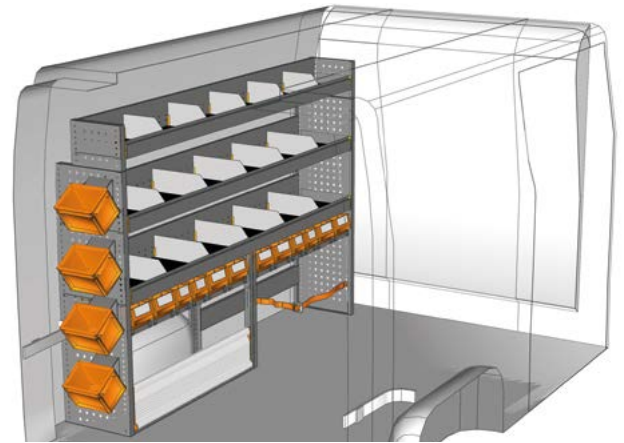

BEISPIEL - EXAMPLE

MA 2014 02*

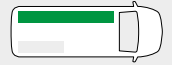

B=2032 T=365 H=1400 mm - W=2032 D=365 H=1400 mm

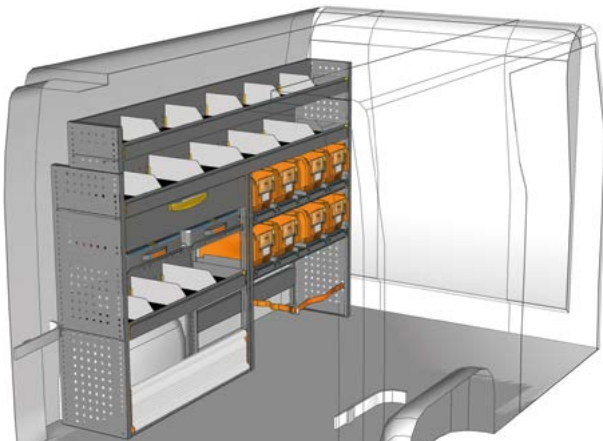

BEISPIEL - EXAMPLE

MA 2014 03*

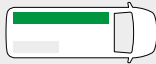

B=2032 T=365 H=1400 mm - W=2032 D=365 H=1400 mm

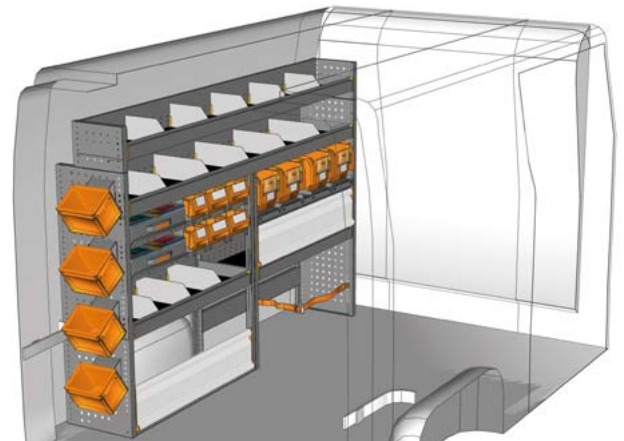

BEISPIEL - EXAMPLE

MA 2014 04*

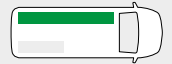

B=2032 T=365 H=1400 mm - W=2032 D=365 H=1400 mm

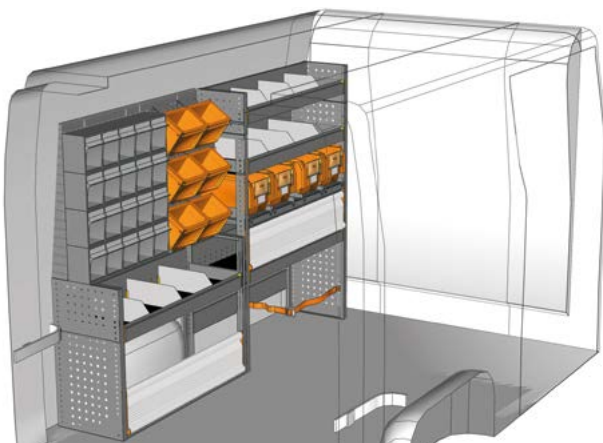

BEISPIEL - EXAMPLE

MA 2014 05*

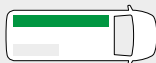

B=2032 T=365 H=1400 mm - W=2032 D=365 H=1400 mm

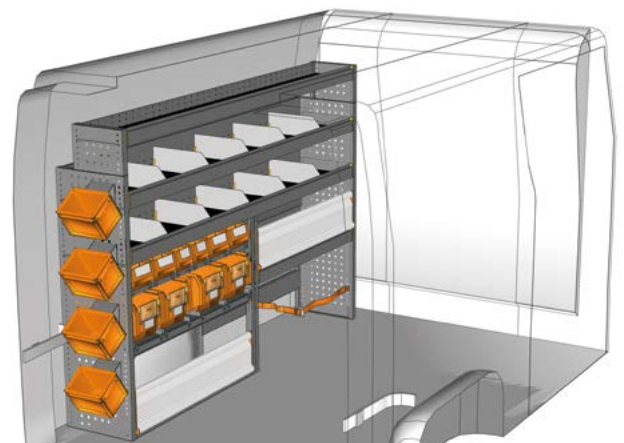

BEISPIEL - EXAMPLE

MA 2014 06*

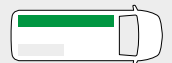

B=2032 T=365 H=1400 mm - W=2032 D=365 H=1400 mm



FAHRZEUGEINRICHTUNGSBEISPIELE - FITTINGS EXAMPLES

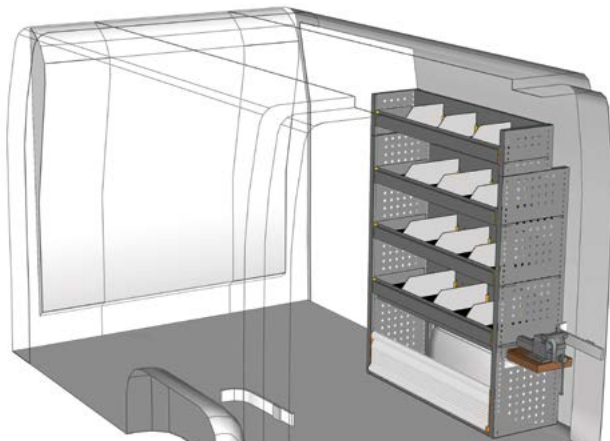

BEISPIEL - EXAMPLE

MA 1014 01*

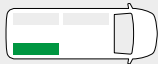

B=1016 T=365 H=1400 mm - W=1016 D=365 H=1400 mm

**Haben Sie Ihre Einrichtung nicht gefunden?
Verlassen Sie sich auf die Profis für
Fahrzeugeinrichtungen.**

Auf der Rückseite dieses Katalogs
finden Sie die nächstgelegene
StoreVan Niederlassung.
Besuchen Sie unsere Web-Seite.



**Didn't find the equipment
you're looking for?
Leave it to our experts.**

See the back of this catalogue
and contact the nearest
StoreVan point or visit our website.

*** Einschließlich Befestigungskit - Fixing kit included**

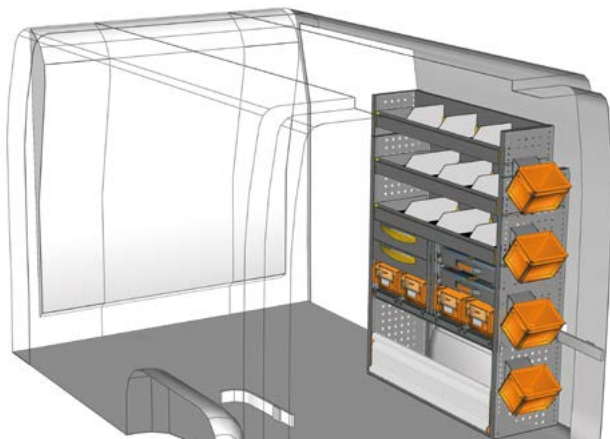

BEISPIEL - EXAMPLE

MA 1014 02*



B=1016 T=365 H=1400 mm - W=1016 D=365 H=1400 mm

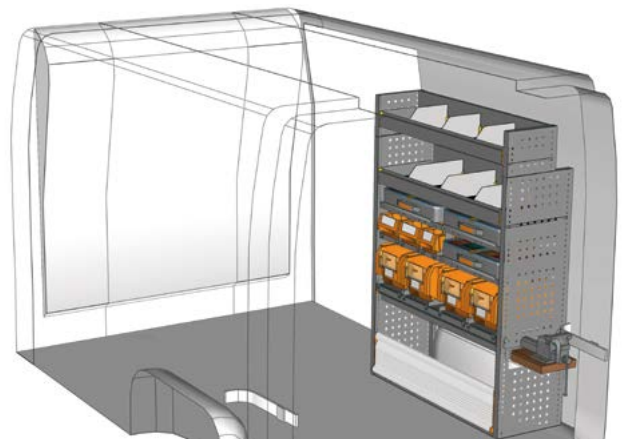

BEISPIEL - EXAMPLE

MA 1014 03*



B=1016 T=365 H=1400 mm - W=1016 D=365 H=1400 mm

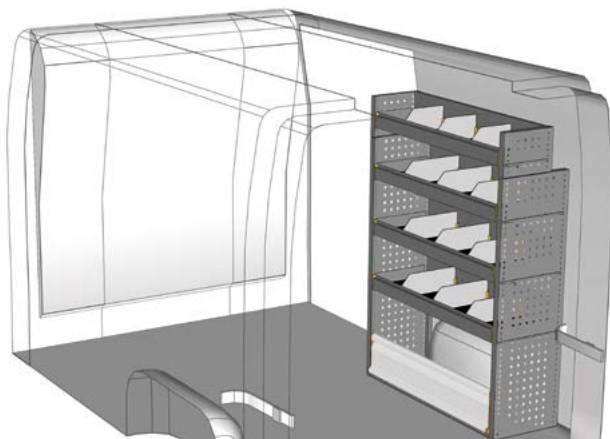

BEISPIEL - EXAMPLE

MA 1014 04*



B=1016 T=365 H=1400 mm - W=1016 D=365 H=1400 mm

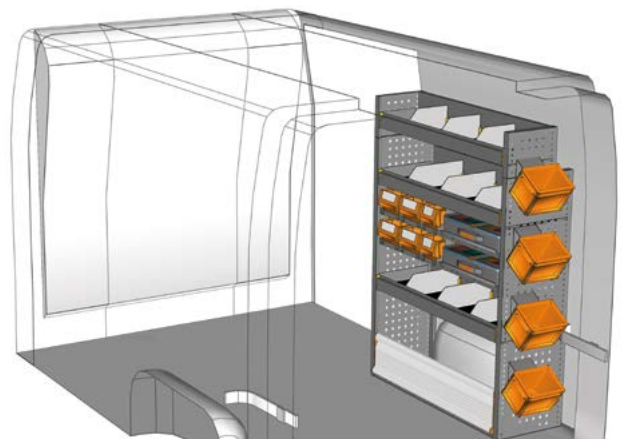

BEISPIEL - EXAMPLE

MA 1014 05*



B=1016 T=365 H=1400 mm - W=1016 D=365 H=1400 mm



FAHRZEUGEINRICHTUNGSBEISPIELE - FITTINGS EXAMPLES

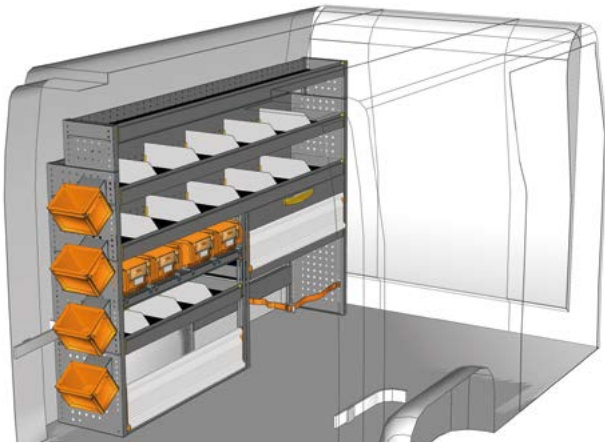

BEISPIEL - EXAMPLE

MA 2014 07*

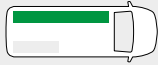

B=2032 T=365 H=1400 mm - W=2032 D=365 H=1400 mm

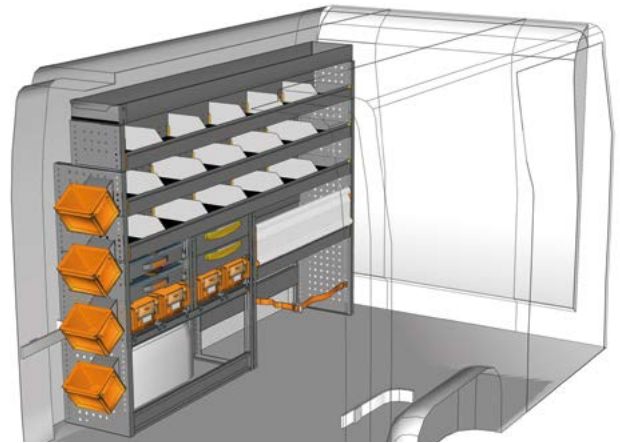

BEISPIEL - EXAMPLE

MA 2015 01*

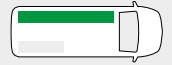

B=2032 T=365 H=1490 mm - W=2032 D=365 H=1490 mm

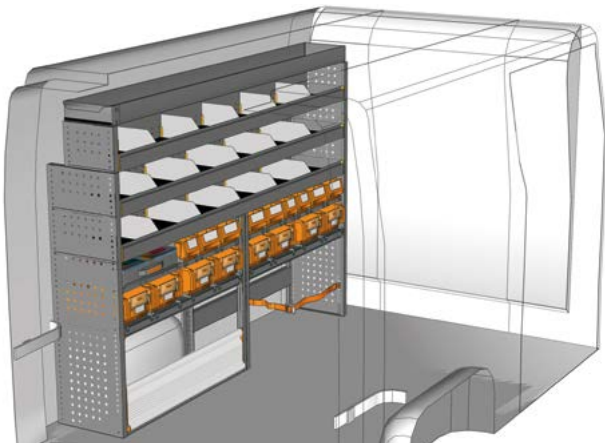

BEISPIEL - EXAMPLE

MA 2015 02*

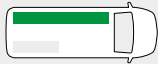

B=2032 T=365 H=1490 mm - W=2032 D=365 H=1490 mm

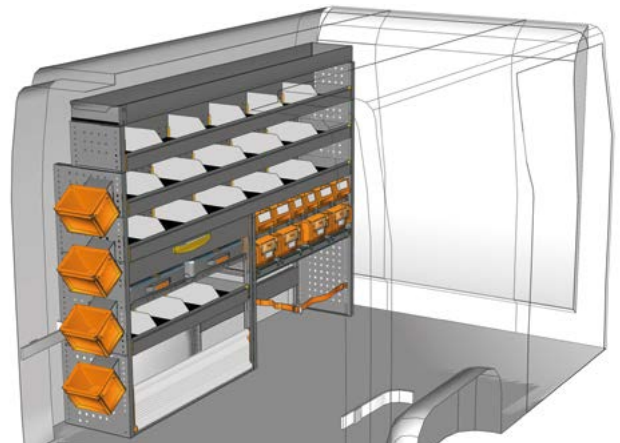

BEISPIEL - EXAMPLE

MA 2015 03*

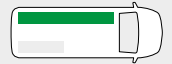

B=2032 T=365 H=1490 mm - W=2032 D=365 H=1490 mm

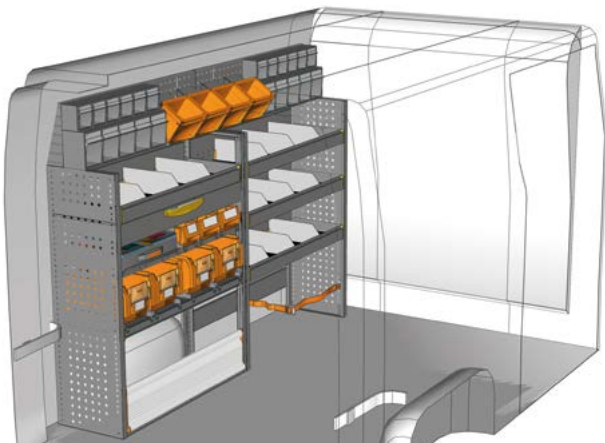

BEISPIEL - EXAMPLE

MA 2015 04*

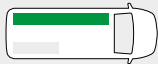

B=2032 T=365 H=1480 mm - W=2032 D=365 H=1480 mm

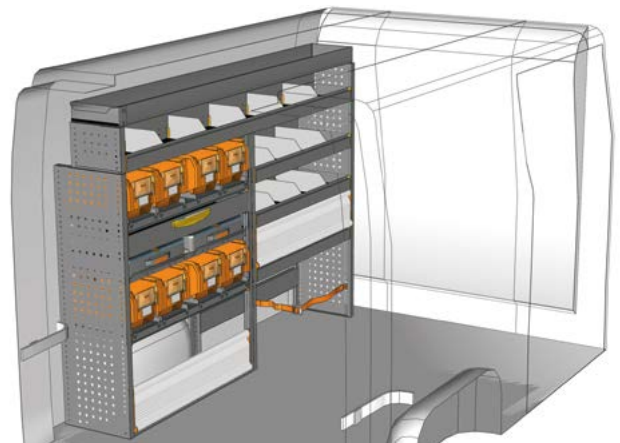

BEISPIEL - EXAMPLE

MA 2015 05*

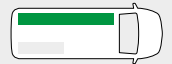

B=2032 T=365 H=1490 mm - W=2032 D=365 H=1490 mm



FAHRZEUGEINRICHTUNGSBEISPIELE - FITTINGS EXAMPLES

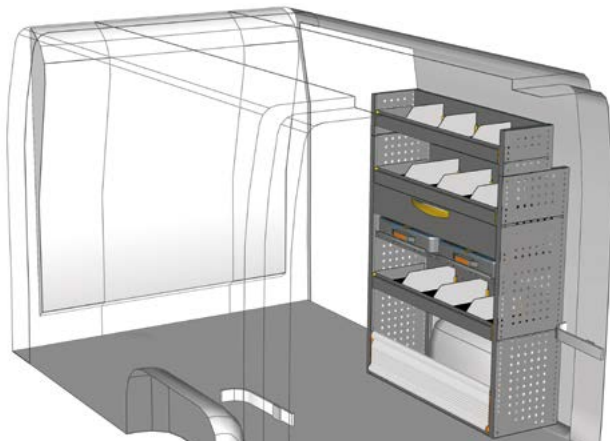

BEISPIEL - EXAMPLE

MA 1014 06*

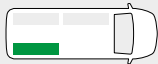

B=1016 T=365 H=1400 mm - W=1016 D=365 H=1400 mm

**Haben Sie Ihre Einrichtung nicht gefunden?
Verlassen Sie sich auf die Profis für
Fahrzeugeinrichtungen.**

Auf der Rückseite dieses Katalogs
finden Sie die nächstgelegene
StoreVan Niederlassung.
Besuchen Sie unsere Web-Seite.



**Didn't find the equipment
you're looking for?
Leave it to our experts.**

See the back of this catalogue
and contact the nearest
StoreVan point or visit our website.

*** Einschließlich Befestigungskit - Fixing kit included**



BEISPIEL - EXAMPLE

MA 1014 07*

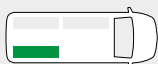

B=1016 T=365 H=1480 mm - W=1016 D=365 H=1480 mm

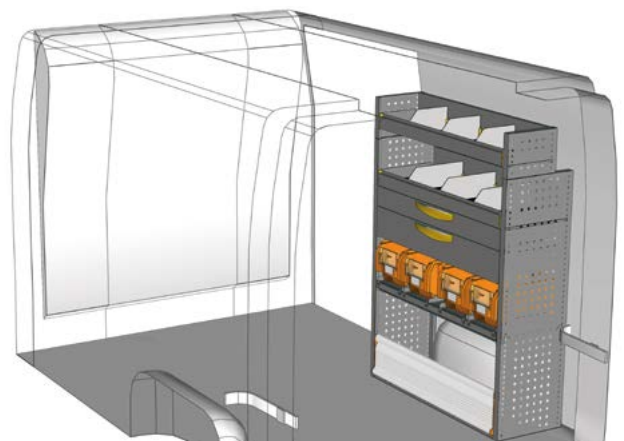

BEISPIEL - EXAMPLE

MA 1014 08*

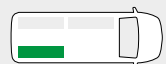

B=1016 T=365 H=1400 mm - W=1016 D=365 H=1400 mm

Ansicht von der Schiebetür
View from side door

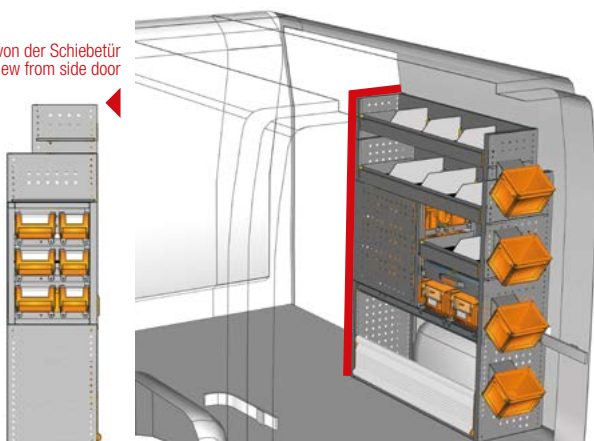

BEISPIEL - EXAMPLE

MA 1014 10*

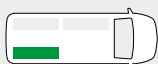

B=1016 T=365 H=1400 mm - W=1016 D=365 H=1400 mm

Ansicht von der Schiebetür
View from side door

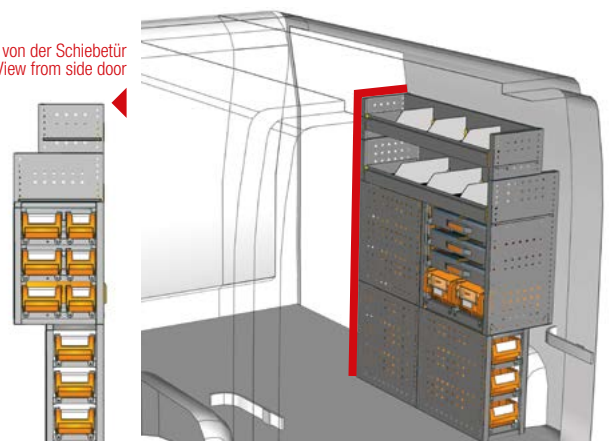

BEISPIEL - EXAMPLE

MA 1014 11*



B=1016 T=365 H=1400 mm - W=1016 D=365 H=1400 mm

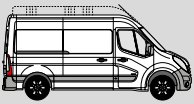

FAHRZEUGEINRICHTUNGSBEISPIELE - FITTINGS EXAMPLES

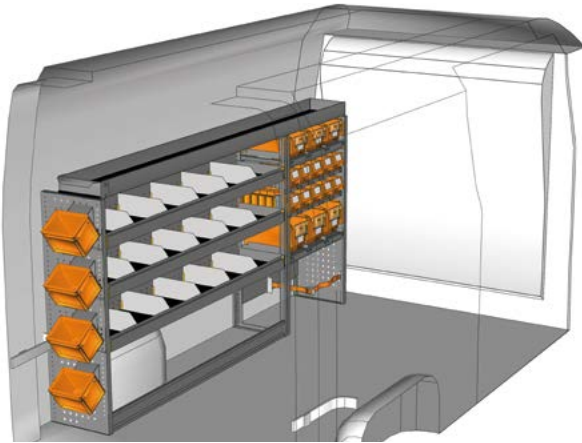
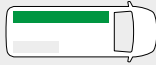
BEISPIEL - EXAMPLE
MA 2413 01*

B=2450 T=365 H=1290 mm - W=2450 D=365 H=1290 mm

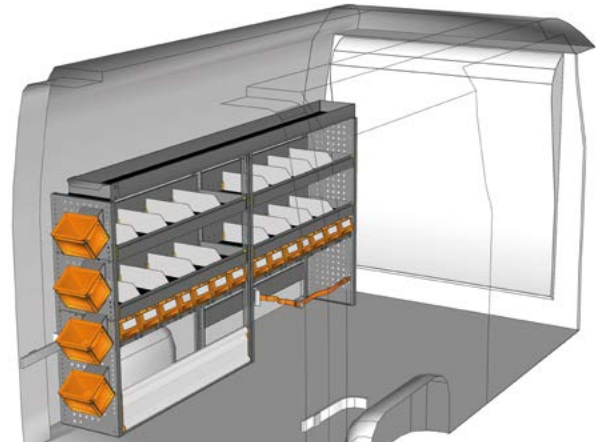
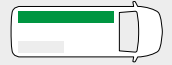
BEISPIEL - EXAMPLE
MA 2413 02*

B=2450 T=365 H=1290 mm - W=2450 D=365 H=1290 mm

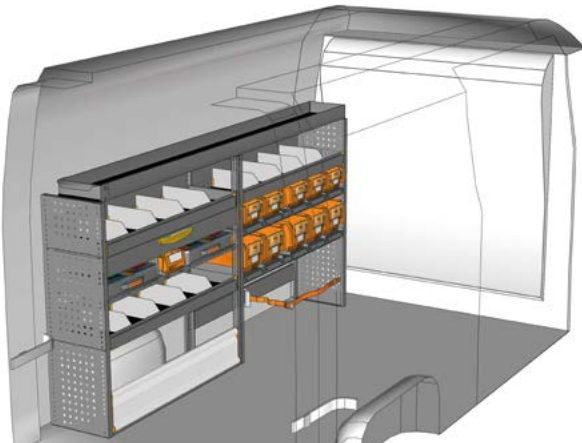
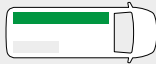
BEISPIEL - EXAMPLE
MA 2413 03*

B=2450 T=365 H=1290 mm - W=2450 D=365 H=1290 mm

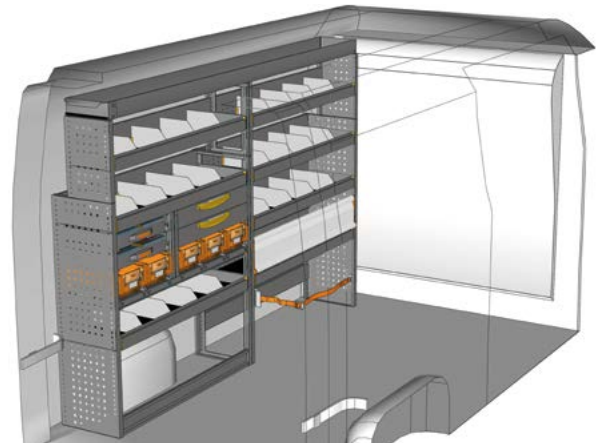
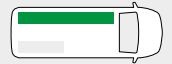
BEISPIEL - EXAMPLE
MA 2417 01*

B=2450 T=365 H=1690 mm - W=2450 D=365 H=1690 mm

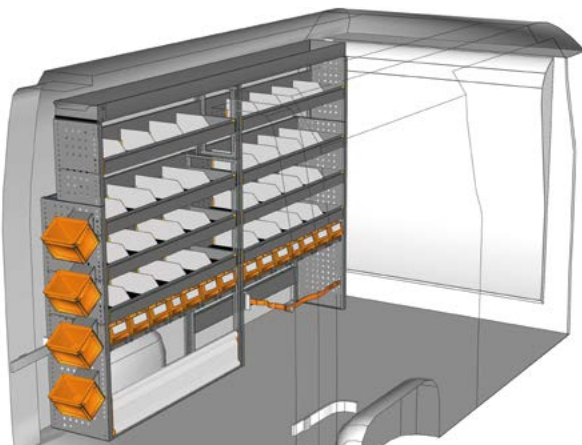
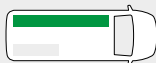
BEISPIEL - EXAMPLE
MA 2417 02*

B=2450 T=365 H=1690 mm - W=2450 D=365 H=1690 mm

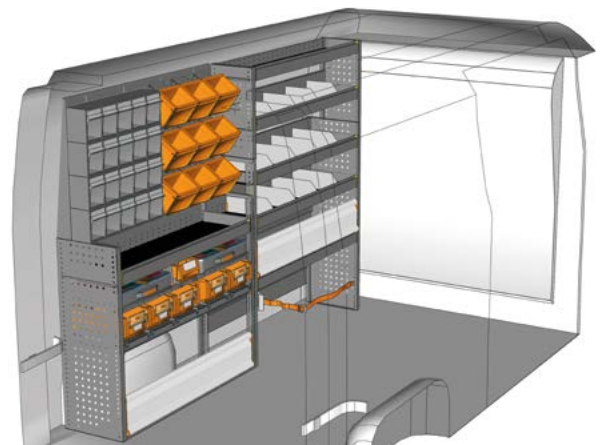
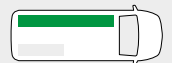
BEISPIEL - EXAMPLE
MA 2417 03*

B=2450 T=365 H=1700 mm - W=2450 D=365 H=1700 mm



FAHRZEUGEINRICHTUNGSBEISPIELE - FITTINGS EXAMPLES



BEISPIEL - EXAMPLE

MA 1217 01*

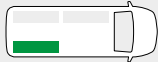

B=1225 T=365 H=1700 mm - W=1225 D=365 H=1700 mm

**Haben Sie Ihre Einrichtung nicht gefunden?
Verlassen Sie sich auf die Profis für
Fahrzeugeinrichtungen.**

Auf der Rückseite dieses Katalogs
finden Sie die nächstgelegene
StoreVan Niederlassung.
Besuchen Sie unsere Web-Seite.



**Didn't find the equipment
you're looking for?
Leave it to our experts.**

See the back of this catalogue
and contact the nearest
StoreVan point or visit our website.

*** Einschließlich Befestigungskit - Fixing kit included**

Ansicht von der Schiebetür
View from side door



BEISPIEL - EXAMPLE

MA 1217 02*

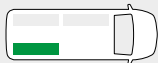

B=1225 T=365 H=1700 mm - W=1225 D=365 H=1700 mm

Ansicht von der Schiebetür
View from side door

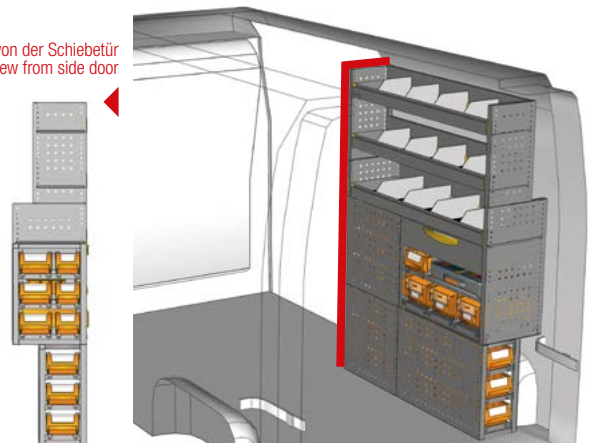

BEISPIEL - EXAMPLE

MA 1217 03*

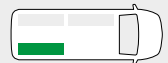

B=1225 T=365 H=1700 mm - W=1225 D=365 H=1700 mm



BEISPIEL - EXAMPLE

MA 1217 04*



B=1225 T=365 H=1700 mm - W=1225 D=365 H=1700 mm

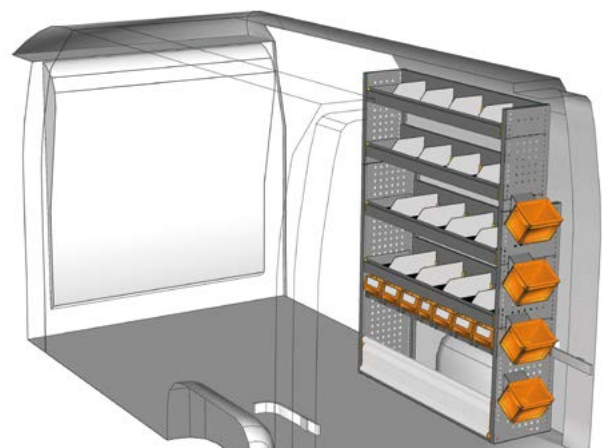

BEISPIEL - EXAMPLE

MA 1217 05*



B=1225 T=365 H=1700 mm - W=1225 D=365 H=1700 mm

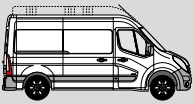

FAHRZEUGEINRICHTUNGSBEISPIELE - FITTINGS EXAMPLES

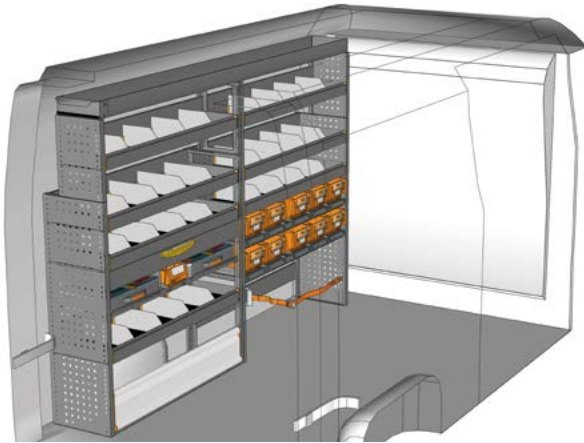

BEISPIEL - EXAMPLE

MA 2417 04*

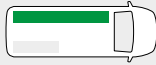

B=2450 T=365 H=1690 mm - W=2450 D=365 H=1690 mm

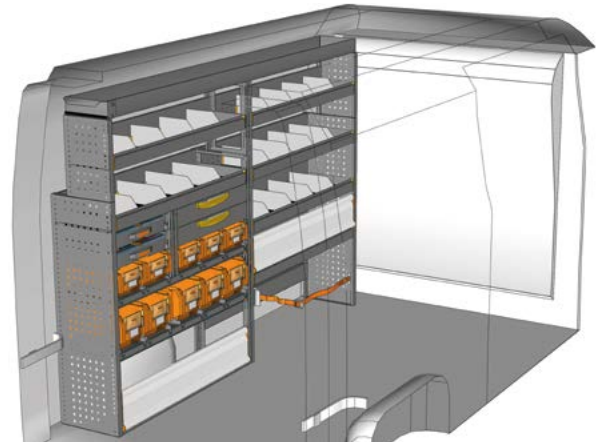

BEISPIEL - EXAMPLE

MA 2417 05*

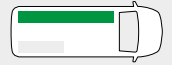

B=2450 T=365 H=1690 mm - W=2450 D=365 H=1690 mm

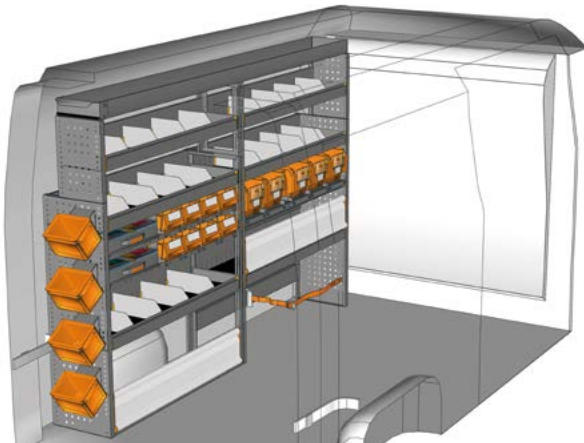

BEISPIEL - EXAMPLE

MA 2417 06*

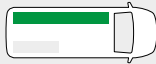

B=2450 T=365 H=1690 mm - W=2450 D=365 H=1690 mm

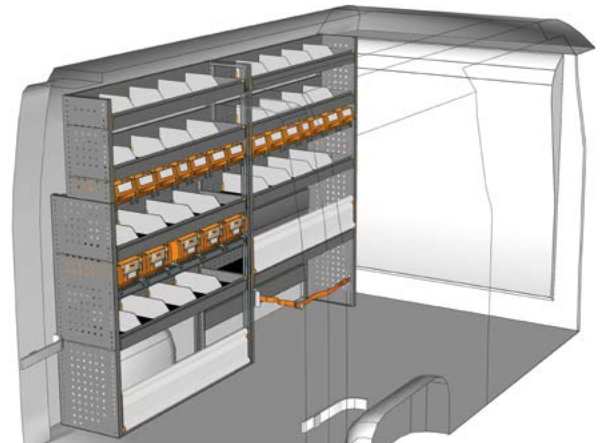

BEISPIEL - EXAMPLE

MA 2417 07*

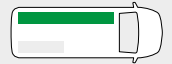

B=2450 T=365 H=1700 mm - W=2450 D=365 H=1700 mm

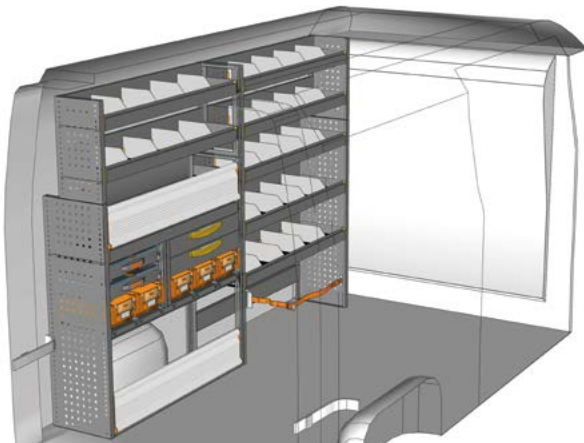

BEISPIEL - EXAMPLE

MA 2417 08*

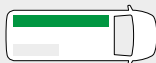

B=2450 T=365 H=1700 mm - W=2450 D=365 H=1700 mm

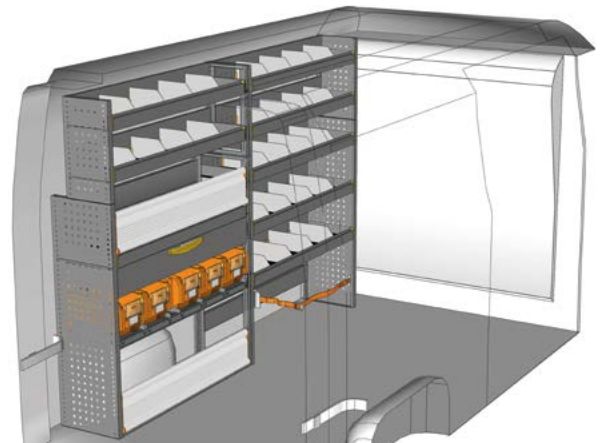

BEISPIEL - EXAMPLE

MA 2417 09*

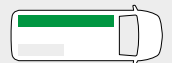

B=2450 T=365 H=1700 mm - W=2450 D=365 H=1700 mm



FAHRZEUGEINRICHTUNGSBEISPIELE - FITTINGS EXAMPLES



BEISPIEL - EXAMPLE

MA 1217 06*

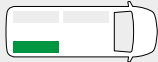

B=1225 T=365 H=1700 mm - W=1225 D=365 H=1700 mm

**Haben Sie Ihre Einrichtung nicht gefunden?
Verlassen Sie sich auf die Profis für
Fahrzeugeinrichtungen.**

Auf der Rückseite dieses Katalogs
finden Sie die nächstgelegene
StoreVan Niederlassung.
Besuchen Sie unsere Web-Seite.



**Didn't find the equipment
you're looking for?
Leave it to our experts.**

See the back of this catalogue
and contact the nearest
StoreVan point or visit our website.

*** Einschließlich Befestigungskit - Fixing kit included**

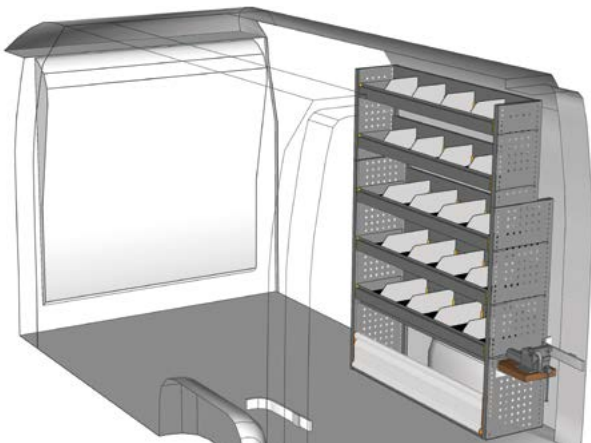

BEISPIEL - EXAMPLE

MA 1217 07*

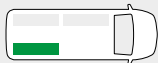

B=1225 T=365 H=1700 mm - W=1225 D=365 H=1700 mm



BEISPIEL - EXAMPLE

MA 1217 08*

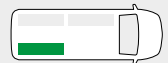

B=1225 T=365 H=1700 mm - W=1225 D=365 H=1700 mm

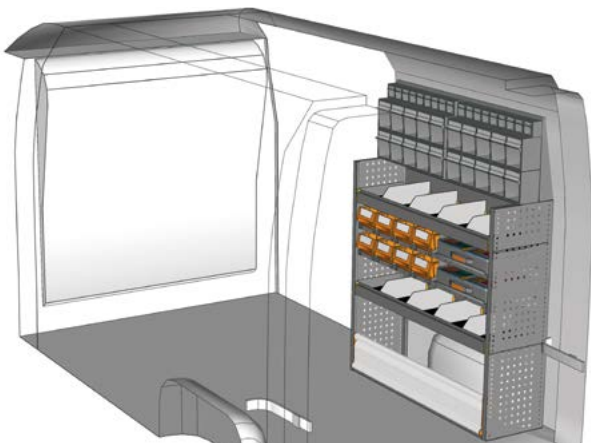

BEISPIEL - EXAMPLE

MA 1217 09*



B=1225 T=365 H=1620 mm - W=1225 D=365 H=1620 mm

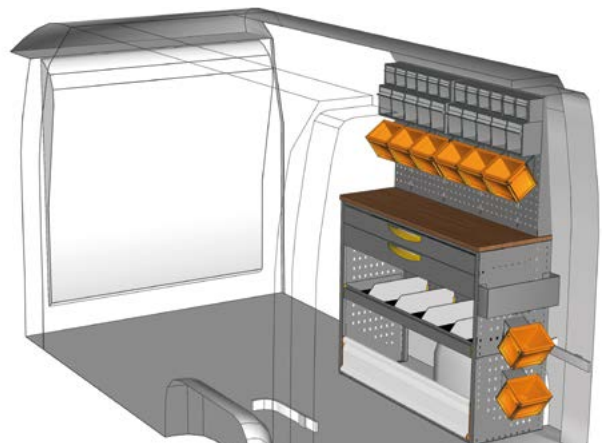

BEISPIEL - EXAMPLE

MA 1217 10*



B=1225 T=445 H=1725 mm - W=1225 D=445 H=1725 mm

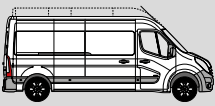

FAHRZEUGEINRICHTUNGSBEISPIELE - FITTINGS EXAMPLES

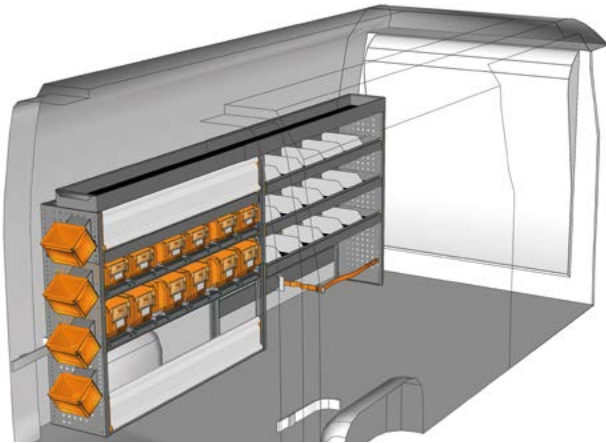

BEISPIEL - EXAMPLE

MA 3013 01*

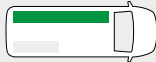

B=3048 T=365 H=1290 mm - W=3048 D=365 H=1290 mm

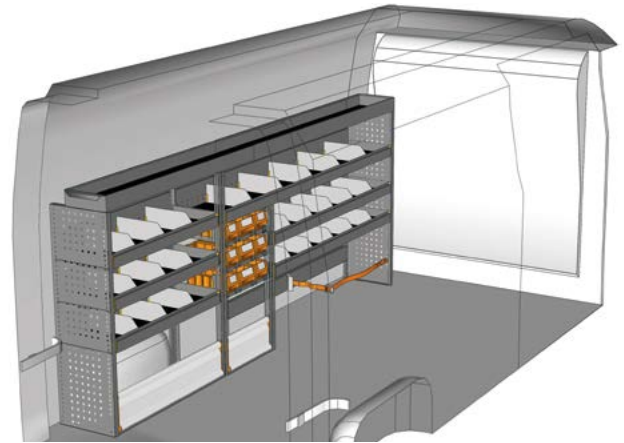

BEISPIEL - EXAMPLE

MA 3013 02*

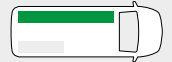

B=3048 T=365 H=1290 mm - W=3048 D=365 H=1290 mm



BEISPIEL - EXAMPLE

MA 3013 03*

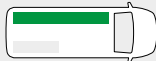

B=3048 T=365 H=1290 mm - W=3048 D=365 H=1290 mm

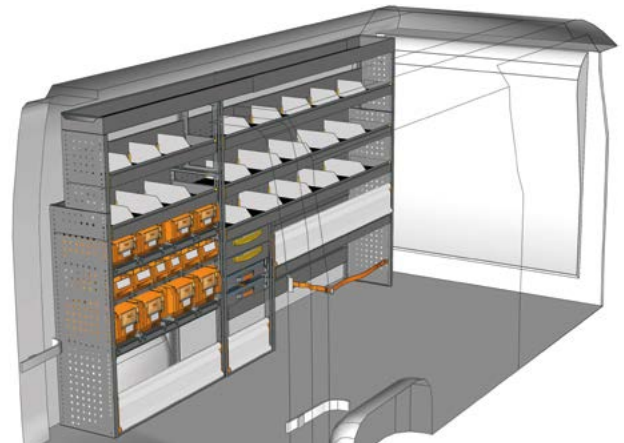

BEISPIEL - EXAMPLE

MA 3017 01*

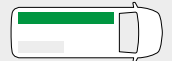

B=3048 T=365 H=1690 mm - W=3048 D=365 H=1690 mm

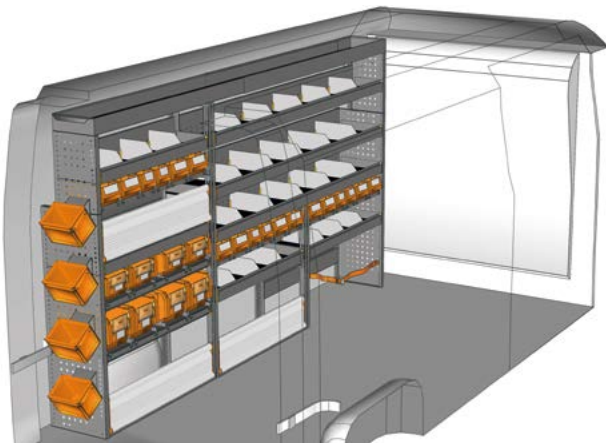

BEISPIEL - EXAMPLE

MA 3017 02*

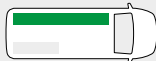

B=3048 T=365 H=1690 mm - W=3048 D=365 H=1690 mm

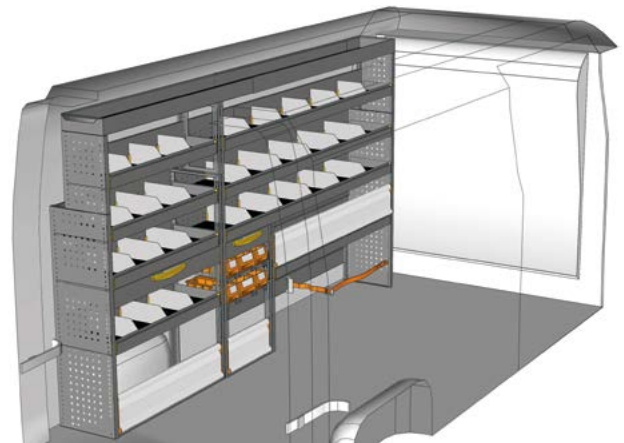

BEISPIEL - EXAMPLE

MA 3017 03*

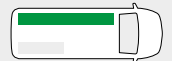

B=3048 T=365 H=1690 mm - W=3048 D=365 H=1690 mm



FAHRZEUGEINRICHTUNGSBEISPIELE - FITTINGS EXAMPLES

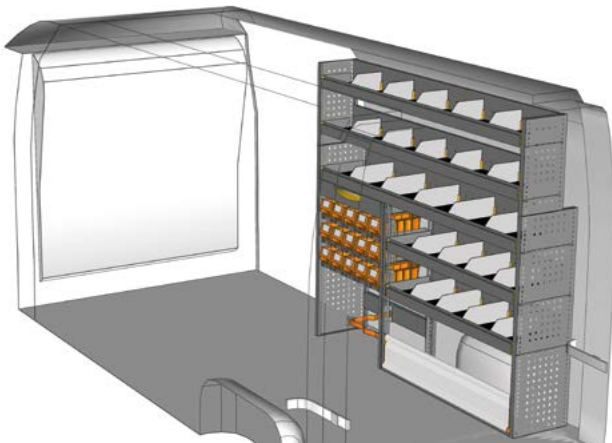

BEISPIEL - EXAMPLE

MA 1917 01*

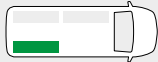

B=1942 T=365 H=1700 mm - W=1942 D=365 H=1700 mm

**Haben Sie Ihre Einrichtung nicht gefunden?
Verlassen Sie sich auf die Profis für
Fahrzeugeinrichtungen.**

Auf der Rückseite dieses Katalogs
finden Sie die nächstgelegene
StoreVan Niederlassung.
Besuchen Sie unsere Web-Seite.



**Didn't find the equipment
you're looking for?
Leave it to our experts.**

See the back of this catalogue
and contact the nearest
StoreVan point or visit our website.

*** Einschließlich Befestigungskit - Fixing kit included**

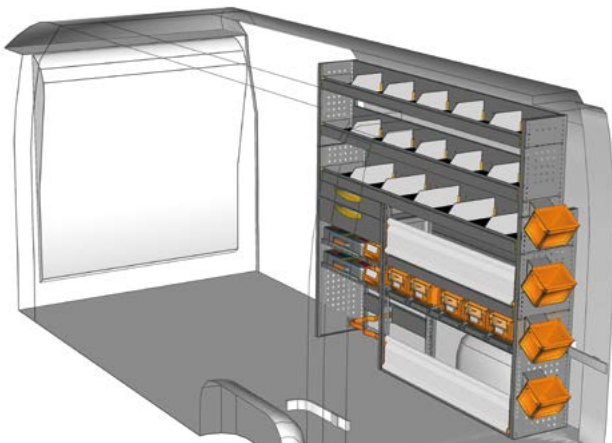

BEISPIEL - EXAMPLE

MA 1917 02*

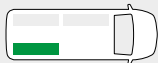

B=1942 T=365 H=1700 mm - W=1942 D=365 H=1700 mm

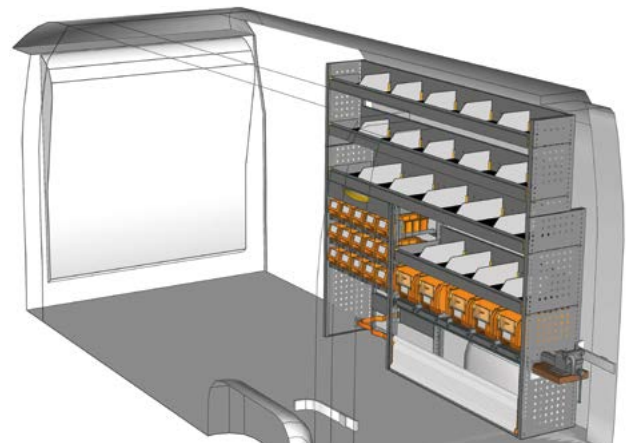

BEISPIEL - EXAMPLE

MA 1917 03*

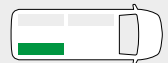

B=1942 T=365 H=1700 mm - W=1942 D=365 H=1700 mm

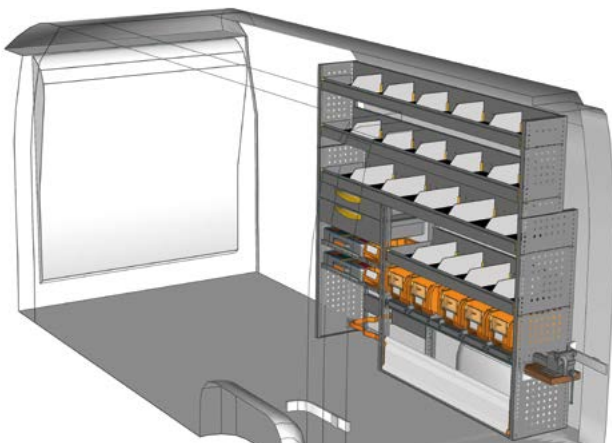

BEISPIEL - EXAMPLE

MA 1917 04*



B=1942 T=365 H=1700 mm - W=1942 D=365 H=1700 mm



BEISPIEL - EXAMPLE

MA 1917 05*

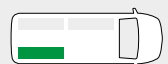

B=1942 T=365 H=1700 mm - W=1942 D=365 H=1700 mm

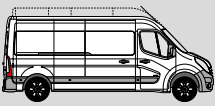

FAHRZEUGEINRICHTUNGSBEISPIELE - FITTINGS EXAMPLES



BEISPIEL - EXAMPLE

MA 3017 04*

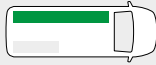

B=3048 T=365 H=1690 mm - W=3048 D=365 H=1690 mm

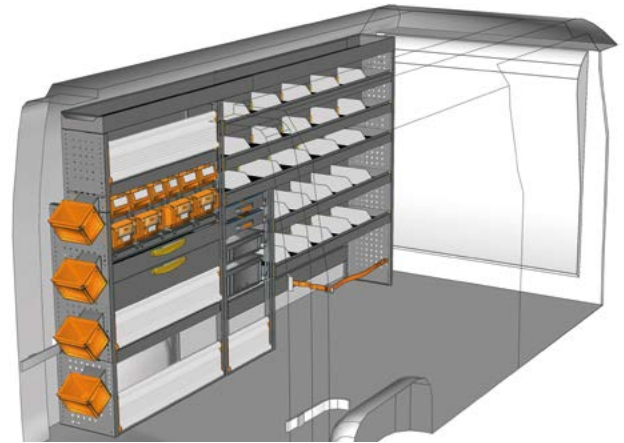

BEISPIEL - EXAMPLE

MA 3017 05*

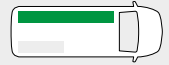

B=3048 T=365 H=1690 mm - W=3048 D=365 H=1690 mm

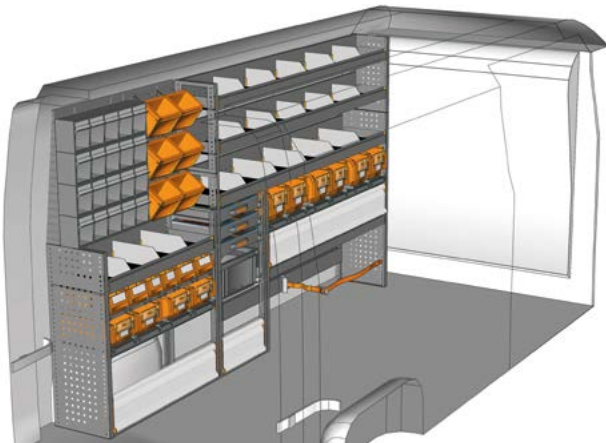

BEISPIEL - EXAMPLE

MA 3017 06*

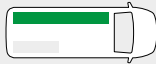

B=3048 T=365 H=1700 mm - W=3048 D=365 H=1700 mm



BEISPIEL - EXAMPLE

MA 3017 07*

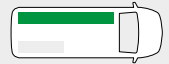

B=3048 T=365 H=1700 mm - W=3048 D=365 H=1700 mm

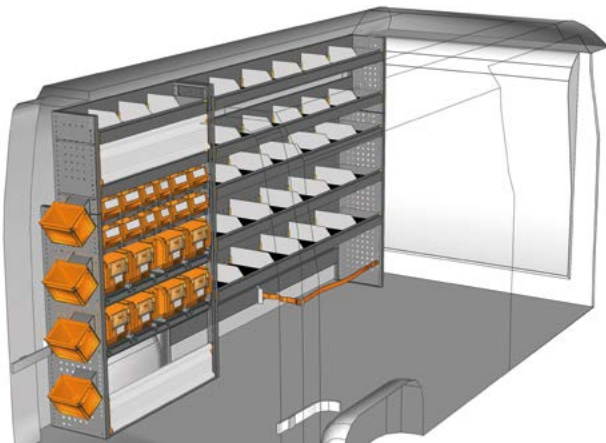

BEISPIEL - EXAMPLE

MA 3017 08*

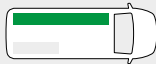

B=3048 T=365 H=1700 mm - W=3048 D=365 H=1700 mm

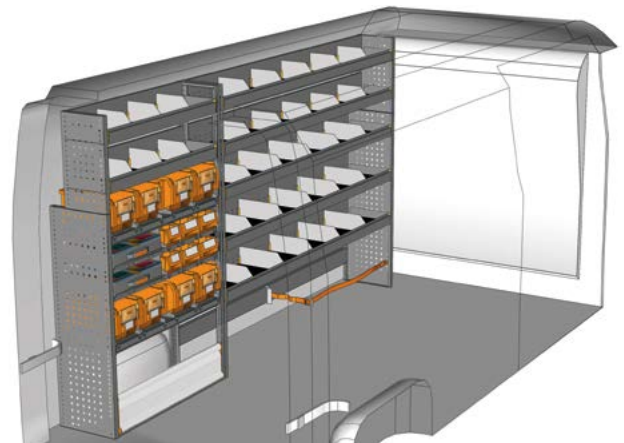

BEISPIEL - EXAMPLE

MA 3017 09*

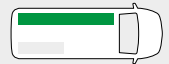

B=3048 T=365 H=1700 mm - W=3048 D=365 H=1700 mm



FAHRZEUGEINRICHTUNGSBEISPIELE - FITTINGS EXAMPLES



BEISPIEL - EXAMPLE

MA 1917 06*

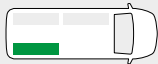

B=1942 T=365 H=1700 mm - W=1942 D=365 H=1700 mm

**Haben Sie Ihre Einrichtung nicht gefunden?
Verlassen Sie sich auf die Profis für
Fahrzeugeinrichtungen.**

Auf der Rückseite dieses Katalogs
finden Sie die nächstgelegene
StoreVan Niederlassung.
Besuchen Sie unsere Web-Seite.



**Didn't find the equipment
you're looking for?
Leave it to our experts.**

See the back of this catalogue
and contact the nearest
StoreVan point or visit our website.

*** Einschließlich Befestigungskit - Fixing kit included**

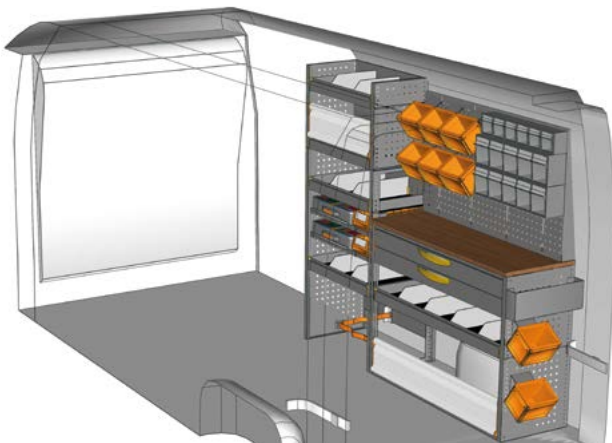

BEISPIEL - EXAMPLE

MA 1917 07*

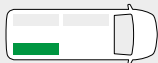

B=1942 T=445 H=1700 mm - W=1942 D=445 H=1700 mm

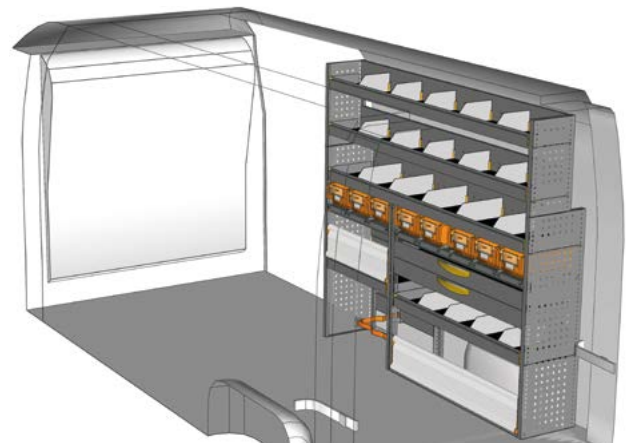

BEISPIEL - EXAMPLE

MA 1917 08*

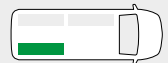

B=1942 T=365 H=1700 mm - W=1942 D=365 H=1700 mm

Ansicht von der Schiebetür
View from side door

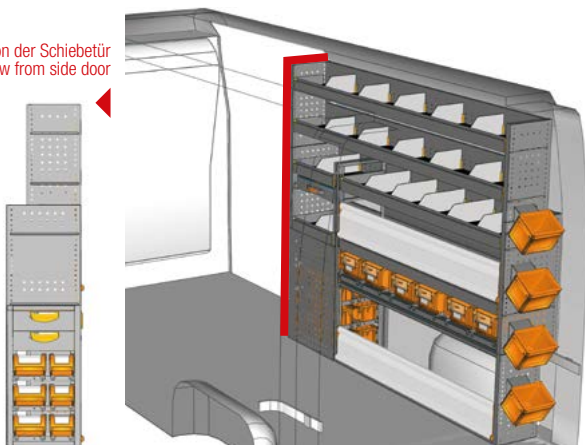

BEISPIEL - EXAMPLE

MA 2017 01*



B=2032 T=365 H=1700 mm - W=2032 D=365 H=1700 mm

Ansicht von der Schiebetür
View from side door

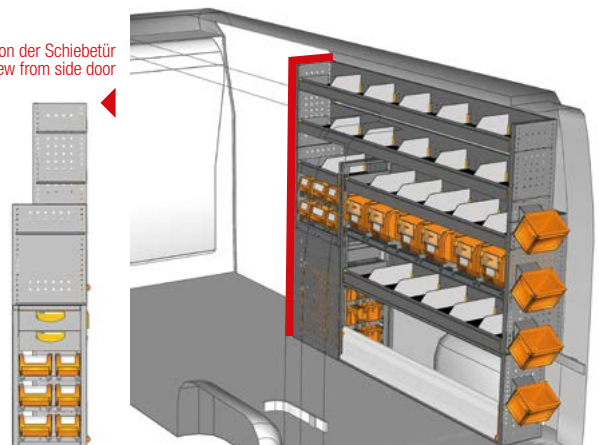

BEISPIEL - EXAMPLE

MA 2017 02*



B=2032 T=365 H=1700 mm - W=2032 D=365 H=1700 mm

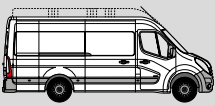

FAHRZEUGEINRICHTUNGSBEISPIELE - FITTINGS EXAMPLES

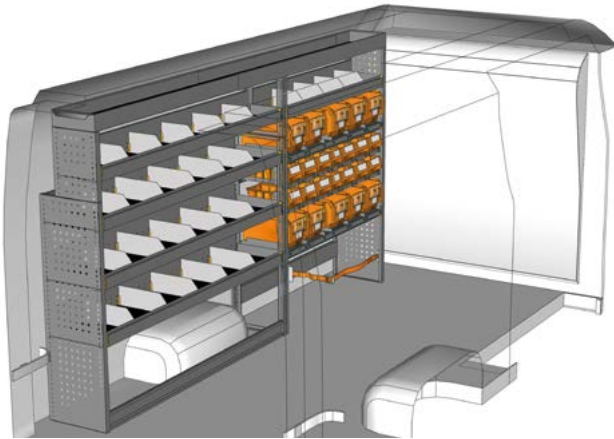

BEISPIEL - EXAMPLE

MA 2916 01*

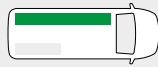

B=2958 T=365 H=1640 mm - W=2958 D=365 H=1640 mm

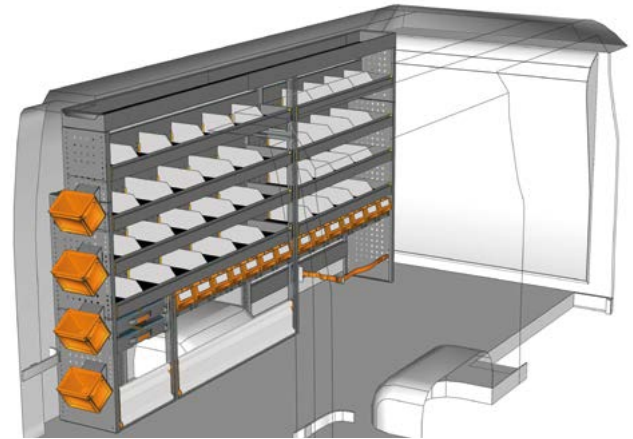

BEISPIEL - EXAMPLE

MA 2916 02*

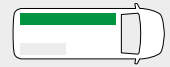

B=2958 T=365 H=1640 mm - W=2958 D=365 H=1640 mm

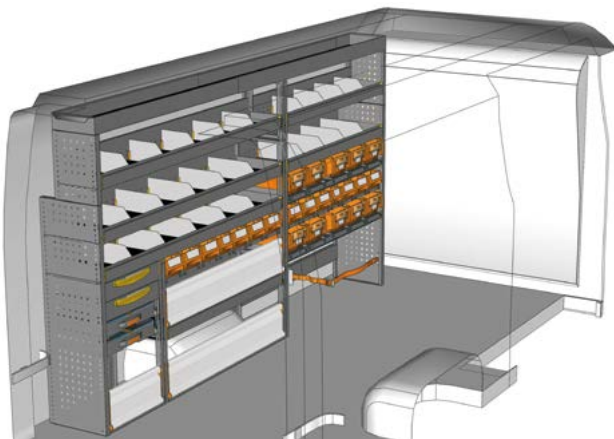

BEISPIEL - EXAMPLE

MA 2916 03*

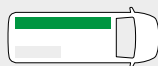

B=2958 T=365 H=1640 mm - W=2958 D=365 H=1640 mm

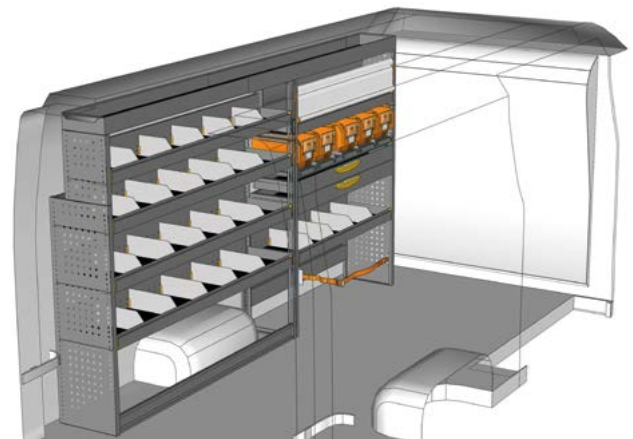

BEISPIEL - EXAMPLE

MA 2916 04*

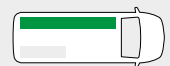

B=2958 T=365 H=1640 mm - W=2958 D=365 H=1640 mm



BEISPIEL - EXAMPLE

MA 2916 05*

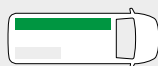

B=2958 T=365 H=1640 mm - W=2958 D=365 H=1640 mm

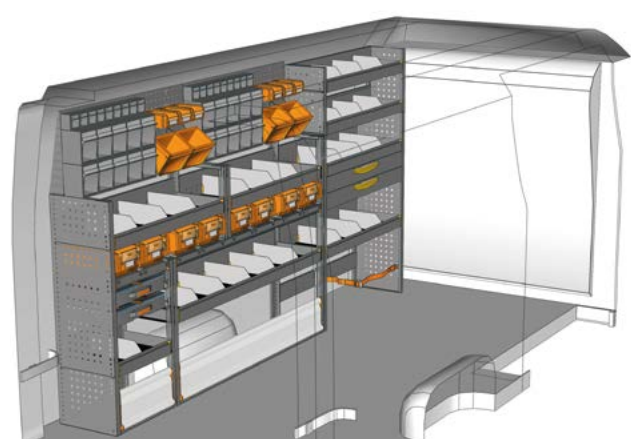

BEISPIEL - EXAMPLE

MA 3016 01*

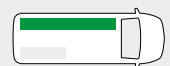

B=3048 T=365 H=1620 mm - W=3048 D=365 H=1620 mm



FAHRZEUGEINRICHTUNGSBEISPIELE - FITTINGS EXAMPLES

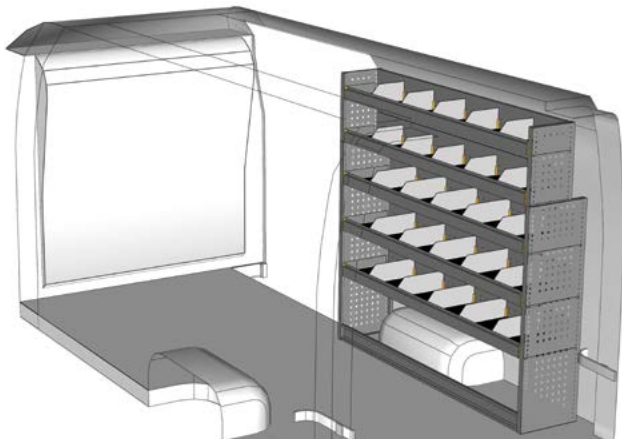

BEISPIEL - EXAMPLE

MA 1716 01*

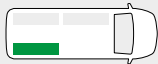

B=1733 T=365 H=1600 mm - W=1733 D=365 H=1600 mm

**Haben Sie Ihre Einrichtung nicht gefunden?
Verlassen Sie sich auf die Profis für
Fahrzeugeinrichtungen.**

Auf der Rückseite dieses Katalogs
finden Sie die nächstgelegene
StoreVan Niederlassung.
Besuchen Sie unsere Web-Seite.



**Didn't find the equipment
you're looking for?
Leave it to our experts.**

See the back of this catalogue
and contact the nearest
StoreVan point or visit our website.

*** Einschließlich Befestigungskit - Fixing kit included**



BEISPIEL - EXAMPLE

MA 1716 02*



B=1733 T=365 H=1600 mm - W=1733 D=365 H=1600 mm

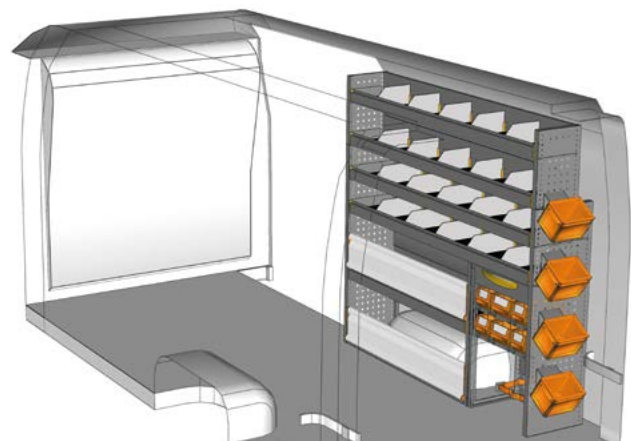

BEISPIEL - EXAMPLE

MA 1716 03*

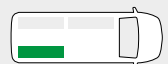

B=1733 T=365 H=1600 mm - W=1733 D=365 H=1600 mm



BEISPIEL - EXAMPLE

MA 1716 04*



B=1733 T=365 H=1600 mm - W=1733 D=365 H=1600 mm



BEISPIEL - EXAMPLE

MA 1716 05*



B=1733 T=445 H=1625 mm - W=1733 D=445 H=1625 mm

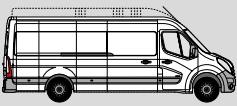

FAHRZEUGEINRICHTUNGSBEISPIELE - FITTINGS EXAMPLES

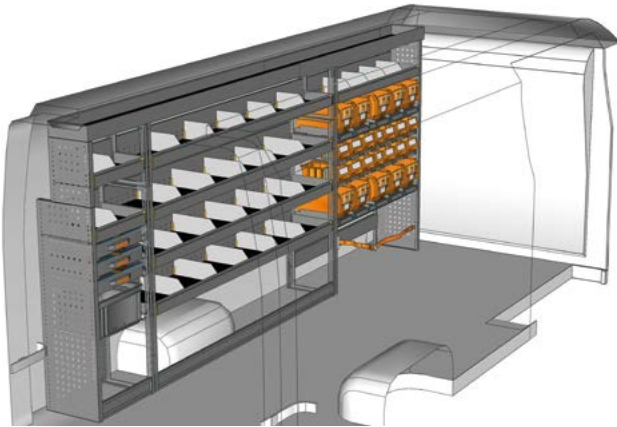

BEISPIEL - EXAMPLE

MA 3716 01*

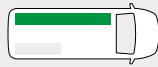

B=3765 T=365 H=1640 mm - W=3765 D=365 H=1640 mm

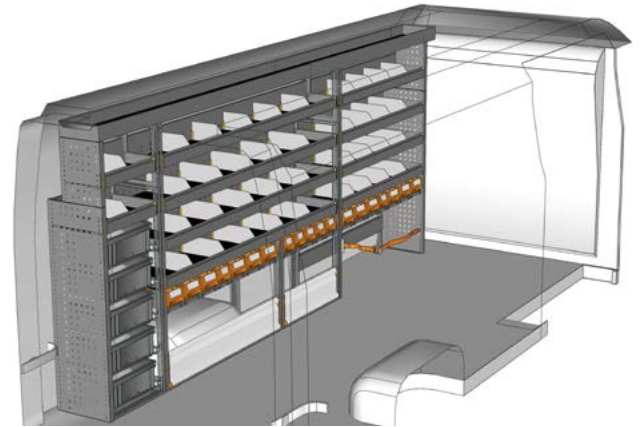

BEISPIEL - EXAMPLE

MA 3716 02*

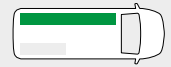

B=3675 T=365 H=1640 mm - W=3675 D=365 H=1640 mm

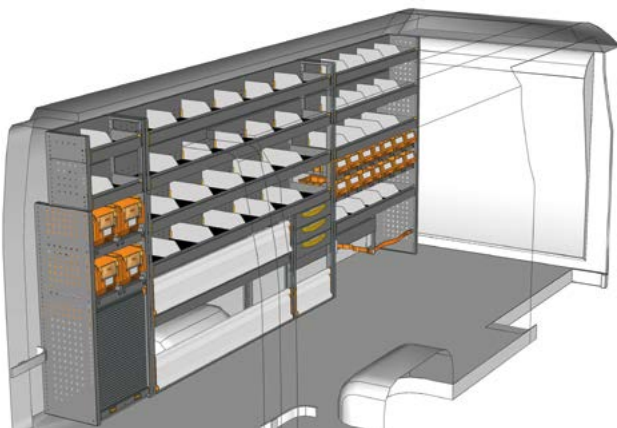

BEISPIEL - EXAMPLE

MA 3716 03*

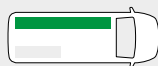

B=3765 T=365 H=1600 mm - W=3765 D=365 H=1600 mm





FAHRZEUGEINRICHTUNGSBEISPIELE - FITTINGS EXAMPLES

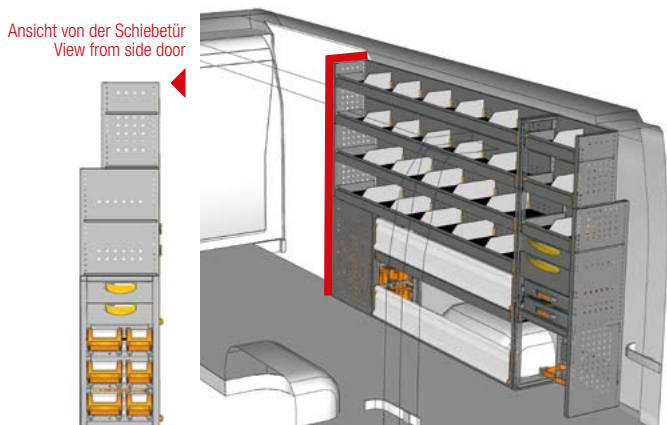

BEISPIEL - EXAMPLE

MA 2516 01*



B=2540 T=365 H=1600 mm - W=2540 D=365 H=1600 mm

**Haben Sie Ihre Einrichtung nicht gefunden?
Verlassen Sie sich auf die Profis für
Fahrzeugeinrichtungen.**

Auf der Rückseite dieses Katalogs
finden Sie die nächstgelegene
StoreVan Niederlassung.
Besuchen Sie unsere Web-Seite.



**Didn't find the equipment
you're looking for?
Leave it to our experts.**

See the back of this catalogue
and contact the nearest
StoreVan point or visit our website.

*** Einschließlich Befestigungskit - Fixing kit included**

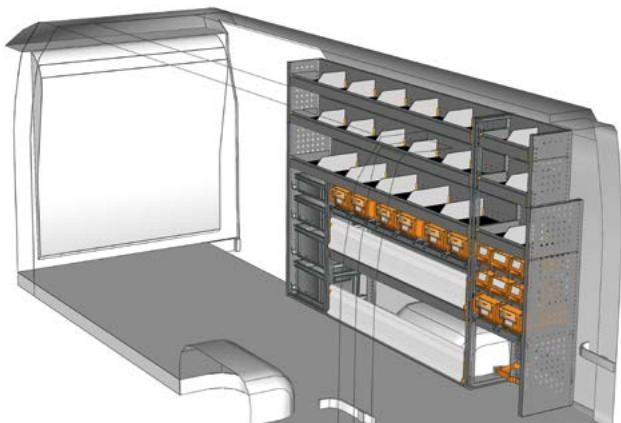

BEISPIEL - EXAMPLE

MA 2516 02*



B=2540 T=365 H=1600 mm - W=2540 D=365 H=1600 mm





NISSAN NV400

KASTENWAGEN - PANEL VAN



DACHTRÄGER UND LEITERTRÄGER - ROOF AND LADDER RACK



FAHRZEUG VEHICLE	DACHTRÄGER ROOF RACK	ABMESSUNGEN DIMENSIONS	GEWICHT WEIGHT	TRAGKRAFT LOAD CAPACITY
	ART. NR. / ITEM NO.			
Fahrzeugtyp - Model L1 H1	POT 219	2750x1700 mm	33,44 kg	166,00 kg
Fahrzeugtyp - Model L1 H2	POT 220	3000x1600 mm	33,23 kg	166,00 kg
Fahrzeugtyp - Model L2 H2	POT 214	3400x1600 mm	34,81 kg	165,00 kg
Fahrzeugtyp - Model L3 H2	POT 215	4000x1600 mm	40,59 kg	159,00 kg
Fahrzeugtyp - Model L4 H2	POT 216	4350x1600 mm	45,80 kg	154,00 kg

POT

- Dachträger bestehend aus:
 - Alu-Querschienen inkl. Befestigungen und Gummiprofilen
 - Seitenwänden aus Aluminium
 - Laderolle aus Aluminium
 - Schraubmaterial aus Edelstahl

- Roof rack complete of:
 - aluminium crossbars with fixing parts and rubber profile
 - aluminium side rails
 - aluminium loading roller
 - fixing screws in stainless steel



FAHRZEUG VEHICLE	LEITERTRÄGER LADDER RACK	ABMESSUNGEN DIMENSIONS	GEWICHT WEIGHT	TRAGKRAFT LOAD CAPACITY
	ART. NR. / ITEM NO.			
Fahrzeugtyp - Model L1 H1	POS 219	2750x1680 mm	61,35 kg	138,00 kg
Fahrzeugtyp - Model L1 H2	POS 220	3000x1580 mm	60,61 kg	139,00 kg
Fahrzeugtyp - Model L2 H2	POS 214	3400x1580 mm	64,30 kg	135,00 kg
Fahrzeugtyp - Model L3 H2	POS 215	4000x1580 mm	69,08 kg	131,00 kg
Fahrzeugtyp - Model L4 H2	POS 216	4350x1580 mm	73,56 kg	126,00 kg

POS

- Leiterträger bestehend aus:
 - Alu-Querschienen inkl. Befestigungen und Gummiprofilen
 - Seitenwand aus Aluminium
 - Laderolle aus Aluminium
 - Leiterschiene aus Aluminium und Edelstahl
 - Schraubmaterial aus Edelstahl

- Ladder rack complete of:
 - aluminium crossbars with fixing parts and rubber profile
 - aluminium side rail
 - aluminium loading roller
 - ladder rack rail made of aluminium and stainless steel
 - fixing screws in stainless steel

- Der Leiterträger kann links oder rechts montiert werden.
- The ladder rack rail can be mounted on the right or left side.





ZUBEHÖR - ACCESSORIES



ART. NR. / ITEM NO. ACS 005

- Papierrollen-Kit Ø 140 mm
- Paper roll holder Ø 140 mm



ART. NR. / ITEM NO. ACS 012

- Papierrollen-Kit Ø 240 mm
- Paper roll holder Ø 240 mm



ART. NR. / ITEM NO. ACS 013

- Silikonträgersatz
- Silicone holder kit



ART. NR. / ITEM NO. ACS 014

- Schlauchhalter
- Cable holder



ART. NR. / ITEM NO. ACS 004

- Erste-Hilfe-Kasten
- First aid kit



ART. NR. / ITEM NO. ACS 006

- Plantasche für DIN A4 Formate
- DIN A4 pocket document holder



ART. NR. / ITEM NO. ACS 007

- Spraydosenhalter
- Spray can holder



ART. NR. / ITEM NO. ACS 015

- Halterung mit 1 Behälter Größe 1PL
- Holder with 1 container mesure 1 PL



ART. NR. / ITEM NO. ACS 016

- Halterung mit 3 Behältern Größe 1PL
- Holder with 3 containers mesure 1 PL



ART. NR. / ITEM NO. ACS 017

- Halterung mit Behälter Größe 2115A
- Holder with box mesure 2115A



ART. NR. / ITEM NO. ACS 001

- Handwasch-Kit
- Hand wash kit



ART. NR. / ITEM NO. ACS 002

- Kanisterhalter mit Kanister Inh. 20 Lt.
- Jerrycan holder with 20 litres iron jerrycan

ZUBEHÖR - ACCESSORIES

ART. NR. / ITEM NO. ACS 003
A

- Halterung mit Gurt für Flaschen und Feuerlöscher
- Holder with belt for gas cylinders and extinguishers

ART. NR. / ITEM NO. ACS 018
B

- Feuerlöscher 4 kg
- Fire extinguisher 4 kg

ART. NR. / ITEM NO. ACS 019

- All Safe Stange L=365 mm und Zurrurt mit Ratschenschloss
- All Safe bar L= 365 mm and ratchet belt

ART. NR. / ITEM NO. ACS 020
C

- All Safe Stange L=445 mm und Zurrurt mit Ratschenschloss
- All Safe bar L= 445 mm and ratchet belt

ART. NR. / ITEM NO. ACS 021

- All Safe Stange L=365 mm und Zurrurt mit Hebelspannschloss
- All Safe bar L= 365 mm and clamp belt

ART. NR. / ITEM NO. ACS 022
D

- All Safe Stange L=445 mm und Zurrurt mit Hebelspannschloss
- All Safe bar L= 445 mm and clamp belt

 Beispiel mit 2 **ART. NR. ACS 003**
 Example with 2 **ITEMS NO. ACS 003**

 Beispiel mit 2 **ART. NR. ACS 019**
 Example with 2 **ITEMS NO. ACS 019**

 Beispiel mit 2 **ART. NR. ACS 021**
 Example with 2 **ITEMS NO. ACS 021**

ART. NR. / ITEM NO. ACS 023

- Satz 10 Magnete Ø 20 mm
- Set of 10 magnets Ø 20 mm

ART. NR. / ITEM NO. ACS 024

- Satz 10 Magnete Ø 25 mm
- Set of 10 magnets Ø 25 mm

ART. NR. / ITEM NO. ACS 025

- LED-Lampe L=600 mm IP20 12V
- LED lamp L=600 mm IP20 12V

LIEFERBEDINGUNGEN

- Bodenplatten und Seitenverkleidungen werden in mehreren Teilen geliefert.
- Dachträger und Leiterträger werden **lose** geliefert.
- Module werden **vormontiert** komplett mit Fahrzeugbefestigungsmaterial geliefert.
- Produkte sollen vorzugsweise von **Vertragshändlern** installiert werden.
- Produkte werden **verpackt** geliefert.
- **3 Jahre Garantie** auf unsere Komponenten.
- Die Tragkräfte beziehen sich auf **gleichmäßig verteilte Last**.

SUPPLY CONDITIONS

- Flooring and linings supplied in several pieces.
- Roof and ladder racks supplied **flat-packed**.
- Modules are supplied **preassembled** complete of fixing material to the vehicle.
- For products installation, please get in touch with our **approved installer's network**.
- Products provided **with packaging**.
- Our products are covered by a **3-years warranty**.
- Load capacities refer to **uniformly distributed loads**.

WWW.STOREVAN.COM



FAMI S.r.l.

Via Stazione Rossano, 13 | 36027 Rosà (VI) | ITALY
phone +39 0424 585455 | fax +39 0424 585482
www.famisp.com | info@famisp.com
www.storevan.com | info@storevan.com